

DK SERIES

DK752DH5

75" 4000 nits 4K UHD Outdoor Ultra-High Brightness Hybrid Kiosk with Light Box

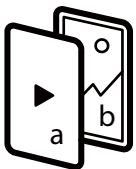

HYBRID
DIGITAL & STATIC

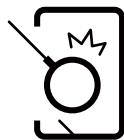

VANDAL
RESISTANT

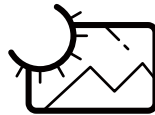

SUNLIGHT
VIEWABLE IMAGE

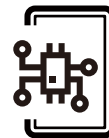

SMART
LIGHT BOX



WEATHER
PROOF

FOR MORE INFORMATION

For more information about DynaScan, visit our website at www.dynascan.com. Copyright © DynaScan Technology Inc. All rights reserved. All specifications and descriptions are subject to change without notice. Reproduction without permission is prohibited.

DynaScan

SPECIFICATION

MODEL	DK752DH5		
DISPLAY	LCD Panel Size	74.52" inches LCD (x1)	
	Native Resolution	3840 x 2160	
	Brightness (w/o glass)	4,000 nits	
	Light Lifetime (Typ.)	100,000 hrs	
	Color Depth	10 bits	
	Contrast Ratio	3000 : 1	
	Response Time (Typ.)	8 ms	
	Viewing Angle	178° / 178°	
	Polarized Sunglasses Support	Yes	
	Touch Function (Optional)	P-Cap touch	
LIGHT BOX	Bezel Width (T/B/L/R)	91.0 / 87.0 / 89.0 / 89.0 mm	
	Poster Size (WxH)	1200 x 1800 mm	
	Kiosk Visual Opening (WxH)	1160.0 x 1710.0 mm	
POWER	Power Supply	Internal	
	Rated Voltage	200-240V ~ 50/60HZ	
	Power On Mode (Typ. /Max)	420 W / 940 W	
MECHANICAL SPECS	Digital Side Bezel Width (T/B/L/R)	97.6 / 137.5 / 203.3 / 203.3 mm	
	Cabinet Color	Black	
	Dimension (LxHxD, w/o stand)	1338.0 x 1888.0 x 250.0 mm	
	Weight	340 kg	
	Orientation	Portrait	
	Glass	Yes	
	Air Vent	Yes	
	High Security Key	Yes	
	USER INTERFACE	Language	English
		Support SNMP (Up to V3.0)	Yes
Dimming Control		Yes	
Image Retention Protection		Yes	
INPUT	HDMI	x3 (2160p)	
	USB 3.0	x1	
	Micro SD Slot	x1	
OUTPUT	Audio	x1	
EXTERNAL CONTROL	RS-232	In x1	
	RJ-45	x2 (LAN)	
INTERNAL PLAYER	Operating System	Android 11.0	
	Processor	Cortex-A73	
	Clock Speed	1.8GHz	
	Main Memory Interface	DDR4, 4G	
	Graphics	Mali-G52	
	Storage	Internal: 16GB eMMC Flash External: Support Micro SD , Up to 128GB(FAT32/NTFS)	
ENVIRONMENT	Multimedia	4K 10bits VP9/H265/H264 video decoders, up to 60fps 1080P other video decoders (VC-1, MPEG-1/2/4, VP8)	
	Operating Temperature	-30° C ~ 50° C	
	Storage Temperature	-20° C ~ 60° C	
	Humidity	5% ~ 95% RH Non-condensing	
CERTIFICATION	Water and Dust resistant design	IP56	
	FCC / CE / IEC60950-22 / RoHS		

DIMENSIONS

Unit: mm [inch]

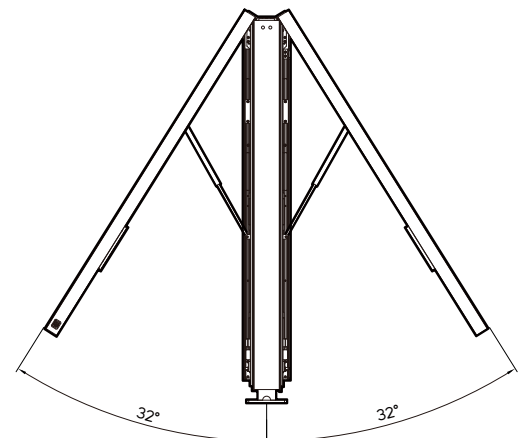
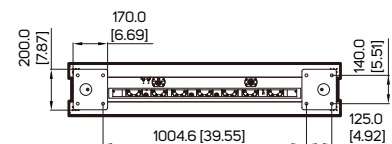
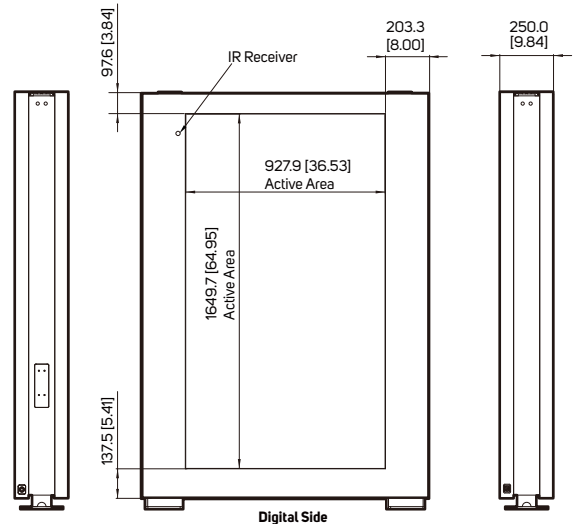
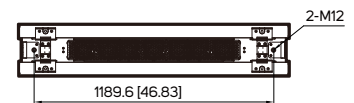
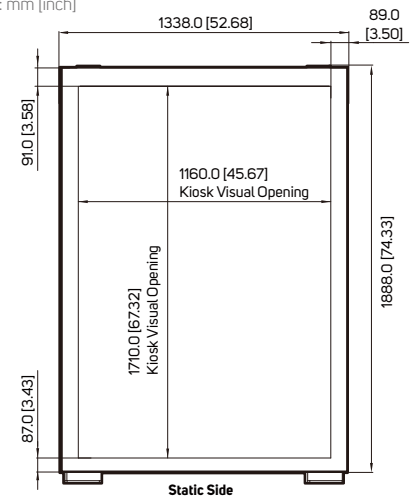

FOR MORE INFORMATION

For more information about DynaScan, visit our website at www.dynascan.com. Copyright © DynaScan Technology Inc. All rights reserved. All specifications and descriptions are subject to change without notice. Reproduction without permission is prohibited.

DynaScan